

SOFT BRONZE PRI-POINT™ MOLD TOOLS

**Strong, Bronze Forging . . . Machined Expressly
for Molded Part & Sprue Removal**

STOP Mold Damage - Only use Molders Choice
Bronze Tools for plastic removal

5 Sizes & Styles

All with **Exclusive PRI-POINT Action!**



Soft nylon nut installed
in tool pivot for convenient PRI-POINT

BDS8-PP	7-3/4" OAL Oval Flat Back .100 Beveled flat edge 61/64" Jaw length serrated	\$65.00	
BG8-PP	8" OAL Oval Rounded Back, relieved .100 Beveled flat edge 61/64" Jaw length	\$69.00	
BC9-PP	8-1/2" OAL 60-Degree Curved Long Nose, Serrated 1-5/64" Jaw length	\$70.00	
BCR9-PP	8-1/2" OAL Curved-Nose Relieved Gripper, Serrated 1-27/32" Jaw length	\$70.00	
BL9-PP	9" OAL Long Nose Serrated 2-3/32" jaw length	\$69.00	

Soft Nylon Nut



Part # BPP5 BUY All 5 and *Deduct 5%!* A **\$359.00 Value** for **\$343.00**
Plus get a Handy Tool Box to store them in!

© 2014 MOLDERS CHOICE, Inc.



24 Hour Service - 7 Days a week
1-800-809-4623
WebSite: www.molderschoice.com • Email: molders@molderschoice.com

BRONZE MOLD TOOLS

NEW
Additional
Sizes and
Features

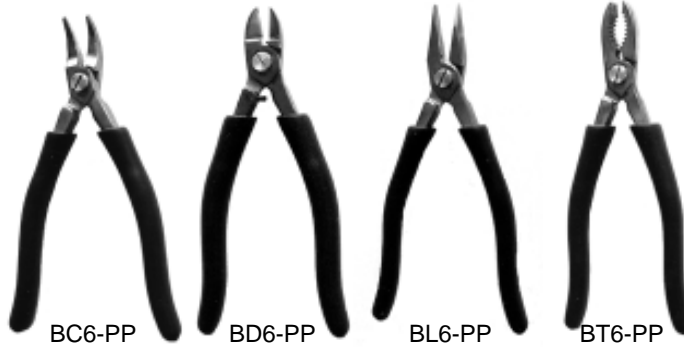

Non-Scratch
Non-Spark
Non-Magnetic

ALL Tools Supplied
with "Exclusive
Pri-Point Action!"

PART #	Type	Size	Head	Edge	Jaw	PRICE
BC6-PP	Pliers	6"	Curved Nose		Grooved, Serrated	\$61.55
BD6-PP	Cutters	6"	Oval	Super flush w/set stop		\$61.55
BD8-PP*	Cutters	8"	Oval	Super flush w/set stop		\$69.00
BL6-PP	Pliers	6"	Long Nose		Grooved, Serrated	\$61.55
BS6-PP*	Combo	6"	Shear Grip	Short thin nose	Serrated	\$61.55
BT6-PP	Pliers	6"	Oval	Gripper, 2-way	Toothed	\$61.00
BT8-PP*	Pliers	8"	Oval	Gripper, 2-way	Toothed	\$69.00

* Not Pictured

BRASS ROD MOLD TOOL

STOP Technicians & Operators from Damaging Mold Surfaces

- REMOVES STUCK PARTS & RUNNERS FAST
- REPLACEABLE BRASS TIPS
- HEAVY DUTY STEEL HANDLE LASTS INDEFINITELY
(won't mushroom over like a brass rod!)

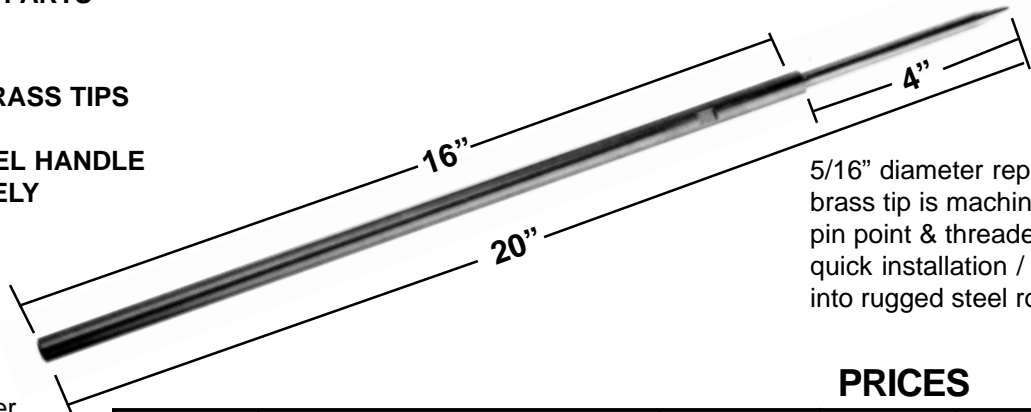

5/16" diameter replacement brass tip is machined to pin point & threaded for quick installation / removal into rugged steel rod.

Strong 1/2" Diameter Steel Rod
Lasts Forever,
Won't Wear Out

PRICES

PART#	DESCRIPTION	QTY 1-9	10-20	21 or more
BMT2	Assembled tool with 1 steel rod / 1 brass tip	\$17.00	\$16.40	\$16.00
RT1	Replacement Brass tip ONLY	\$4.70 each		

© 2010 MOLDERS CHOICE, Inc.



24 Hour Service - 7 Days a week
1-800-809-4623
 WebSite: www.molderschoice.com • Email: molders@molderschoice.com

POKR - Plastic Mold Tools

Reduce Damage to your Molds, use the POKR!

NEW
IN STOCK
TO SHIP NOW

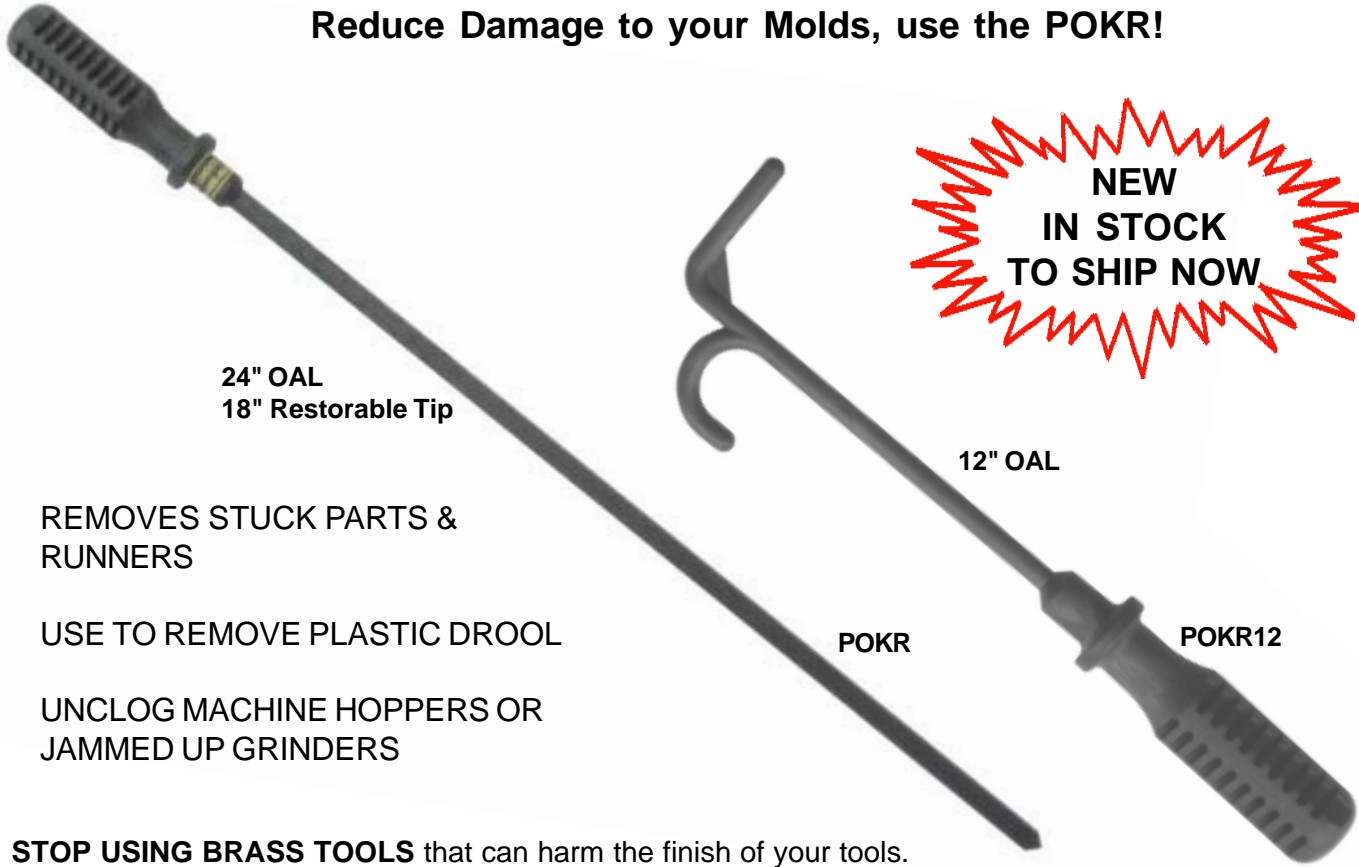

**24" OAL
18" Restorable Tip**

12" OAL

REMOVES STUCK PARTS & RUNNERS

USE TO REMOVE PLASTIC DROOL

UNCLOG MACHINE HOPPERS OR JAMMED UP GRINDERS

POKR

POKR12

STOP USING BRASS TOOLS that can harm the finish of your tools.
The POKR is made of 100% recyclable 6/6 Nylon and wont mark up your tool

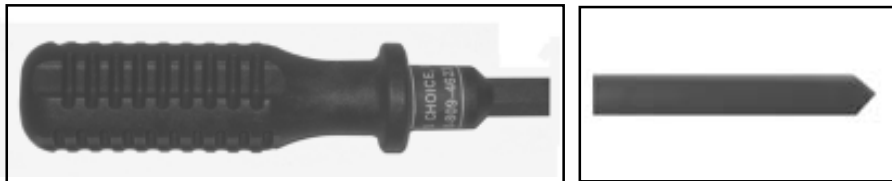

Simply cut, grind, sand or form a new tip when worn or sculpture the tip for a special application.

Buy one for every machine and Process Engineer in your plant

PART #	Description	PRICES		
		1-25	26-49	50+
POKR	24"OAL	\$2.21	\$2.17	\$2.09
POKR12	12"OAL Right Angle & J Hook	\$2.21	\$2.17	\$2.09
VAR4	Variety Pack POKR, POKR12 SCR14, SCR925	\$8.50		



Variety Pack

© 2009 MOLDERS CHOICE, Inc.



24 Hour Service - 7 Days a week
1-800-809-4623
WebSite: www.molderschoice.com • Email: modlers@molderschoice.com

SCRAPER - Plastic Mold Tools

Reduce Damage to your Molds, use the SCRAPER!

**NEW
IN STOCK
TO SHIP NOW**



14" OAL x 1" WIDE

REMOVES STUCK PARTS & RUNNERS

USE TO REMOVE PLASTIC DROOL

INCLUDES HANDY NOZZLE TIP RADIUS GAUGE

9" OAL x 2-1/2" WIDE

SCR925

SCR14

STOP USING BRASS TOOLS that can harm the finish of your tools. The SCRAPER is made of 100% recyclable 6/6 Nylon and won't mark up your mold.

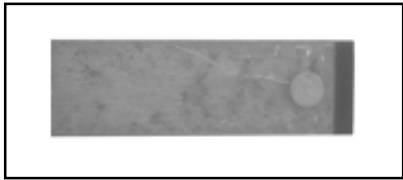
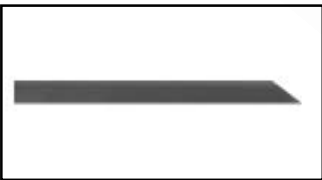
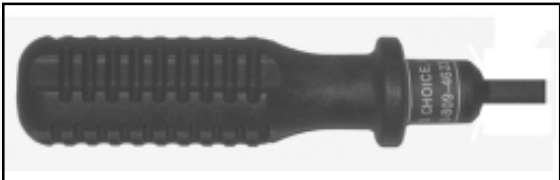

Simply cut, grind, sand or form a new edge when worn.

Buy one for every machine and Process Engineer in your plant

PART #	Description	PRICES		
		1-25	26-49	50+
SCR14	14"OAL x 1"W	\$2.21	\$2.17	\$2.09
SCR925	9"OAL x 2-1/2"	\$2.21	\$2.17	\$2.09
VAR4	Variety Pack POKR, POKR12 SCR14, SCR925	\$8.50		



Variety Pack

© 2009 MOLDERS CHOICE, Inc.



24 Hour Service - 7 Days a week
1-800-809-4623
 WebSite: www.molderschoice.com • Email: molders@molderschoice.com

PROPANE CYLINDER BASE

The safe way is the best way!

- Designed to prevent tip-over
- 5" base is small enough for everyday use
- Fits all standard 14.1 oz. cylinders



Part #	Price
PCS500	\$3.00



© 2009 MOLDERS CHOICE, Inc.



24 Hour Service - 7 Days a week
1-800-809-4623
WebSite: www.molderschoice.com • Email: molders@molderschoice.com

SAFETY NO-BOUNCE® HAMMERS



**Safe, Durable and Universal Hammer
Replaces brass, aluminum and
dead-blow hammers!**

**Available in
6 oz, 1, 2 & 3 lb.**

- Replace Only the Tip,
not the whole hammer
- Durable
 - Will not mar mold surfaces
- Replaceable tips offered in
Tenite or Nylon material

Hickory handles last longer
and reduce shock

Gruv-Loc Tips

Never come loose

- No threads to strip
- Easy to install & replace, just press them on
- Design provides a fully controlled blow with 50% greater impact.
- Design also helps prevent hazard of flying secondary tools.

No-Bounce® Hammers

PART #	Weight	Face Dia	PRICE
MHT06	6oz.	7/8"	\$34.00
MHT1	1lb.	1-1/4"	\$35.00
MHT2	2lb	1-3/4"	\$37.00
MHT3	3lb	2-1/8"	\$55.00
MHT4K*	All 4 above Hammers		\$142.00

* A \$153.00 Value SAVE \$13.00!

Replacement Tips

TENITE		NYLON	
PART #	PRICE	PART #	PRICE
RT06T	\$1.70	RT06N	\$6.70
RT1T	\$2.50	RT1N	\$7.50
RT2T	\$4.00	RT2N	\$9.00
RT3T	\$5.50	RT3N	\$13.70

Safety No-Bounce® Tappers



- Hand-held tapper lets you reach where hammers can't
- Replaceable tips available

PART #	Dia	Length	Weight	PRICE
TP1	1-1/4"	5"	12oz.	\$19.00
TP2	1-1/4"	8"	19oz.	\$20.00
TP2-1	1-3/4"	6"	27oz.	\$24.50
TP2-2	1-3/4"	8"	42oz.	\$25.50
TP2-3	1-3/4"	9-1/2"	49oz.	\$26.00

© Registered Trademark of American Aerospace

©2009 MOLDERS CHOICE, Inc.



24 Hour Service - 7 Days a week
1-800-809-4623

WebSite: www.molderschoice.com • Email: molders@molderschoice.com