

BRONZE MOLD TOOLS

NEW
Additional
Sizes and
Features

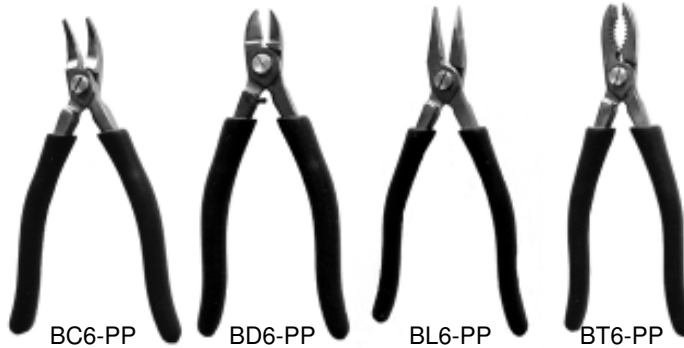

Non-Scratch
Non-Spark
Non-Magnetic

ALL Tools Supplied
with "Exclusive
Pri-Point Action!"

PART #	Type	Size	Head	Edge	Jaw	PRICE
BC6-PP	Pliers	6"	Curved Nose		Grooved, Serrated	\$63.00
BD6-PP	Cutters	6"	Oval	Super flush w/set stop		\$63.00
BD8-PP*	Cutters	8"	Oval	Super flush w/set stop		\$70.00
BL6-PP	Pliers	6"	Long Nose		Grooved, Serrated	\$63.00
BS6-PP*	Combo	6"	Shear Grip	Short thin nose	Serrated	\$63.00
BT6-PP	Pliers	6"	Oval	Gripper, 2-way	Toothed	\$63.00
BT8-PP*	Pliers	8"	Oval	Gripper, 2-way	Toothed	\$70.00

* Not Pictured

BRASS ROD MOLD TOOL

STOP Technicians & Operators from Damaging Mold Surfaces

- REMOVES STUCK PARTS & RUNNERS FAST
- REPLACEABLE BRASS TIPS
- HEAVY DUTY STEEL HANDLE LASTS INDEFINITELY
(won't mushroom over like a brass rod!)

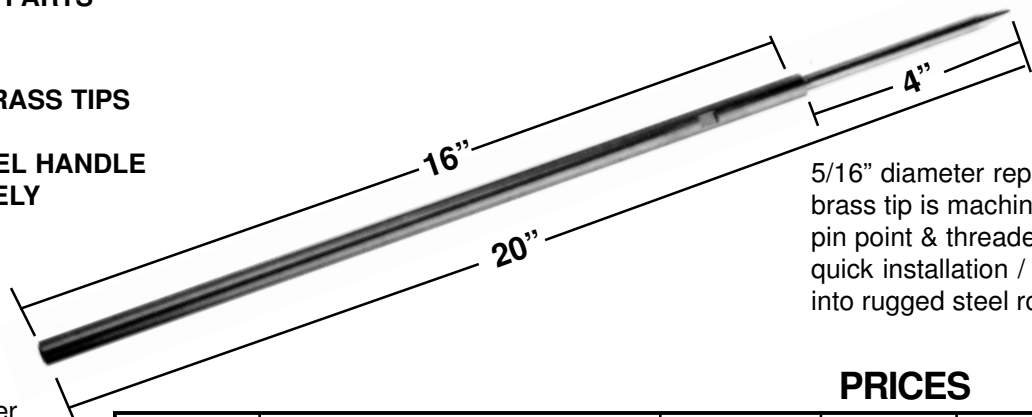

5/16" diameter replacement brass tip is machined to pin point & threaded for quick installation / removal into rugged steel rod.

Strong 1/2" Diameter Steel Rod
Lasts Forever,
Won't Wear Out

PRICES

PART#	DESCRIPTION	QTY 1-9	10-20	21 or more
BMT2	Assembled tool with 1 steel rod / 1 brass tip	\$21.00	\$20.50	\$20.00
RT1	Replacement Brass tip ONLY	\$7.00 each		

© 2018 MOLDERS CHOICE, Inc.



24 Hour Service - 7 Days a week
1-800-809-4623
WebSite: www.molderschoice.com • Email: molders@molderschoice.com