

Right Angle MOLD CHUTE

Stops Part Loss. Helps Direct Parts to Conveyor or Box.

**Easily Mounts to Mold Halves.
Opens and Closes with the Mold for
Protection Against Contamination.**

- **Magnetic Mounting** allows quick and easy:
 - Initial Installation
 - Removal for Mold Maintenance
 - Movement from Mold to Mold
- **Reduce Scrap** by preventing parts loss.
- **Improve Quality** by preventing parts contamination.
- **Easily Cleaned.**



Angled to drop parts gently to box or conveyor.

Side Discharge

PART#	Open Length A	Clearance Height B	Chute Length C	Open Width D	Chute Height E	Chute Width F	PRICE
RMC-20	8"	6"	18"	8"	4"	5"	\$163.00
RMC-25	10"	8"	24"	8"	5"	6"	\$163.00
RMC-30	12"	9"	28"	10"	6"	7"	\$178.00
RMC-35	14"	10"	28"	10"	6"	7"	\$183.00
RMC-40	16"	10"	31"	12"	7"	8"	\$193.00
RMC-45	18"	10"	33"	14"	8"	8"	\$213.00
RMC-50	20"	11"	35"	14"	8"	8"	\$210300
RMC-55	22"	12"	38"	16"	8"	9"	\$223.00
RMC-60	24"	14"	40"	18"	9"	10"	\$239.00

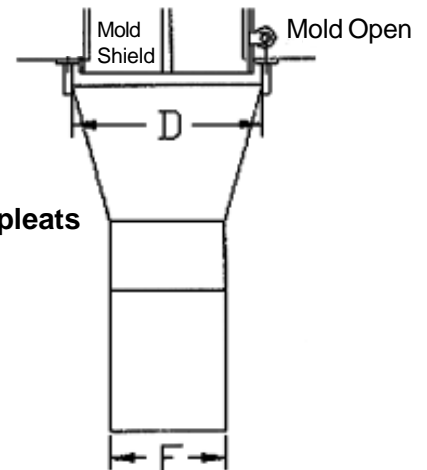
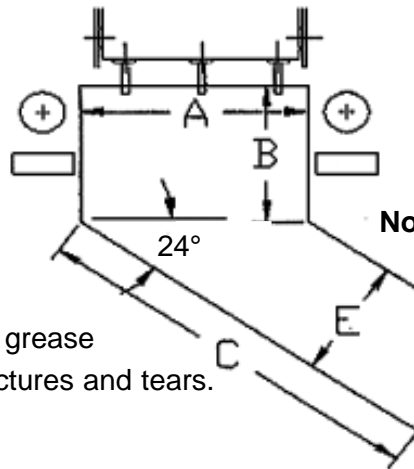

Low-Durometer PVC

- Does not absorb oil or grease
- Resists abrasion, punctures and tears.

© 2017 MOLDERS CHOICE, Inc.



24 Hour Service - 7 Days a week
1-800-809-4623
 WebSite: www.molderschoice.com • Email: modlers@molderschoice.com

Inline MOLD CHUTE

Stops Part Loss. Helps Direct Parts to Conveyor or Box.

**Easily Mounts to Machine Frame.
Remains Open at All Times.**

- **Magnetic Mounting** allows quick and easy:
 - Initial Installation
 - Removal for Mold Maintenance
 - Movement from Mold to Mold
- **Reduces Scrap** by preventing parts loss.
- **Improves Quality** by preventing parts contamination.
- **Easily Cleaned**

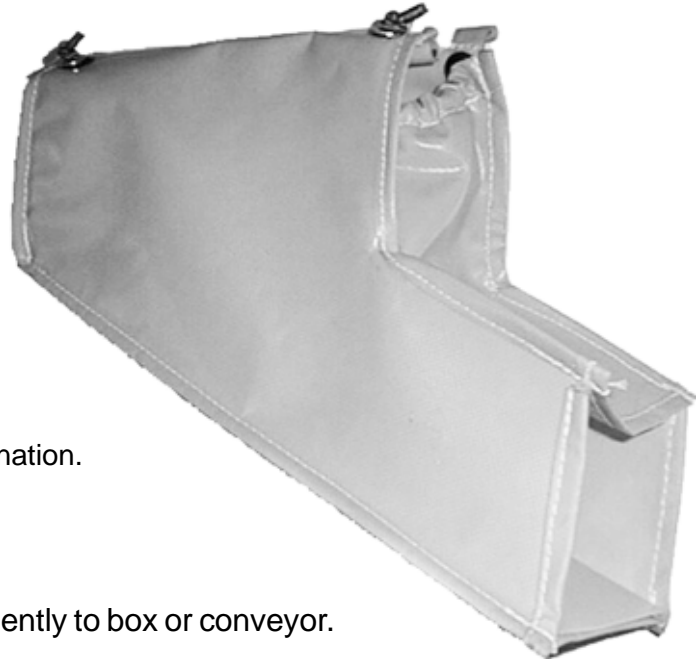

Angled to drop parts gently to box or conveyor.

PART#	Open Length A	Clearance Height B	Chute Length C	Open Width D	Chute Height E	Chute Width F	PRICE
IMC-20	8"	6"	20"	8"	4"	6"	\$163.00
IMC-25	10"	6"	22"	10"	5"	7"	\$163.00
IMC-30	12"	6"	25"	12"	6"	8"	\$178.00
IMC-35	14"	7.2"	27"	14"	6"	8"	\$183.00
IMC-40	16"	8.4"	29"	16"	7"	9"	\$193.00
IMC-45	18"	8.4"	31"	18"	8"	10"	\$213.00
IMC-50	20"	9.3"	33"	20"	8"	10"	\$213.00
IMC-55	22"	10.5"	35"	22"	9"	11"	\$223.00
IMC-60	24"	11.8"	37"	24"	9"	12"	\$239.00

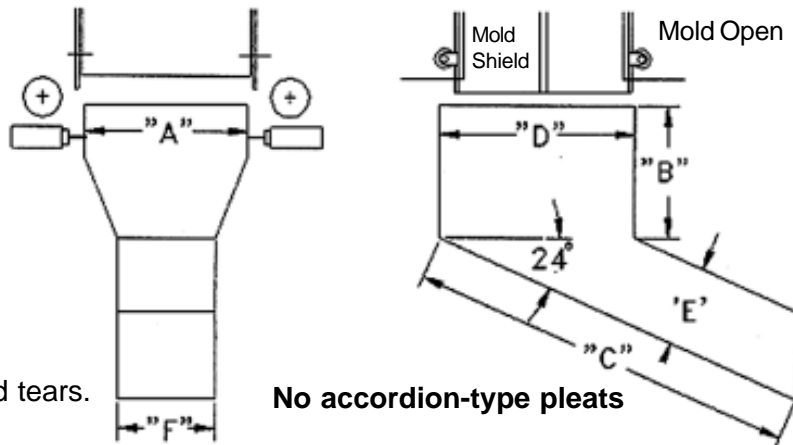

Low-Durometer PVC

- Does not absorb oil or grease
- Resists abrasion, punctures and tears.

No accordion-type pleats

© 2017 MOLDERS CHOICE, Inc.



24 Hour Service - 7 Days a week
1-800-809-4623
 WebSite: www.molderschoice.com • Email: molders@molderschoice.com

Inline Soft Drop MOLD CHUTE

Stops Part Loss. Helps Direct Parts to Conveyor or Box.

- **Magnetic Mounting** allows quick and easy:
 - Initial Installation
 - Removal for Mold Maintenance
 - Movement from Mold to Mold
- **Reduce Scrap** by preventing parts loss.
- **Improve Quality** by preventing parts contamination.



PART#	Mold Width A	Chute Height B	Chute Length C	Mold Open D	PRICE
ISD-25	10"	22"	24"	8"	\$173.00
ISD-30	11"	23"	26"	10"	\$178.00
ISD-35	12"	24"	28"	10"	\$183.00
ISD-40	13"	25"	30"	12"	\$188.00
ISD-45	14"	26"	32"	14"	\$198.00
ISD-50	16"	27"	34"	14"	\$213.00
ISD-55	18"	28"	36"	16"	\$218.00
ISD-60	20"	29"	38"	18"	\$223.00
ISD-65	22"	30"	40"	18"	\$229.00
ISD-70	24"	31"	42"	18"	\$242.00
ISD-75	26"	32"	44"	20"	\$244.00
ISD-80	28"	33"	46"	20"	\$249.00
ISD-85	30"	34"	48"	22"	\$256.00
ISD-90	32"	35"	50"	22"	\$267.00
ISD-95	34"	36"	52"	23.5"	\$291.00
ISD-100	36"	37"	56"	23.5"	\$300.00
ISD-105	38"	38"	60"	25.5"	\$310.00

Important Please Note:
 The discharge height of chute will be made the same size as dimension "D" Mold Open unless otherwise specified by user

- A - _____
Mold Width
- B - _____
Chute Height
- C - _____
Chute Length
- D - _____
Mold Open
- E - _____
Exit Height
- F - _____
Conveyor Width

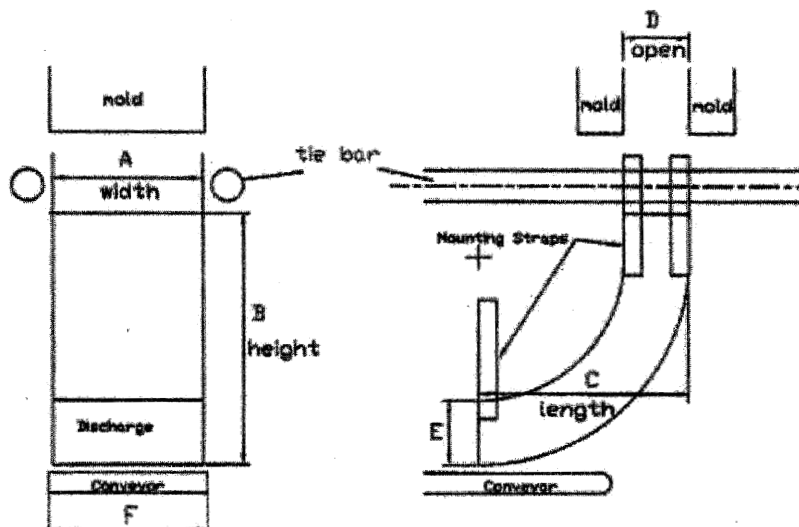

© 2017 MOLDERS CHOICE, Inc.



24 Hour Service - 7 Days a week
1-800-809-4623
 WebSite: www.molderschoice.com • Email: modlers@molderschoice.com

Right Angle Soft Drop MOLD CHUTE

Stops Part Loss. Helps Direct Parts to Conveyor or Box.

- **Magnetic Mounting** allows quick and easy:
 - Initial Installation
 - Removal for Mold Maintenance
 - Movement from Mold to Mold
- **Reduce Scrap** by preventing parts loss.
- **Improve Quality** by preventing parts contamination.

PART#	Mold Width A	Chute Height B	Chute Length C	Mold Open D	PRICE
RSD-25	10"	22"	24"	8"	\$170.00
RSD-30	11"	23"	26"	10"	\$175.00
RSD-35	12"	24"	28"	10"	\$190.00
RSD-40	13"	25"	30"	12"	\$195.00
RSD-45	14"	26"	32"	14"	\$205.00
RSD-50	16"	27"	34"	14"	\$217.00
RSD-55	18"	28"	36"	16"	\$223.00
RSD-60	20"	29"	38"	18"	\$236.00
RSD-65	22"	30"	40"	18"	\$238.00
RSD-70	24"	31"	42"	18"	\$248.00
RSD-75	26"	32"	44"	20"	\$256.00
RSD-80	28"	33"	46"	20"	\$261.00
RSD-85	30"	34"	48"	22"	\$269.00
RSD-90	32"	35"	50"	22"	\$285.00
RSD-95	34"	36"	52"	23.5"	\$292.00
RSD-100	36"	37"	56"	23.5"	\$300.00
RSD-105	38"	38"	60"	25.5"	\$339.00



Important Please Note:
 The discharge height of chute will be made the same size as dimension "A" Mold Width unless otherwise specified by user

- A - _____
Mold Width
- B - _____
Chute Height
- C - _____
Chute Length
- D - _____
Mold Open
- E - _____
Exit Height
- F - _____
Conveyor Width

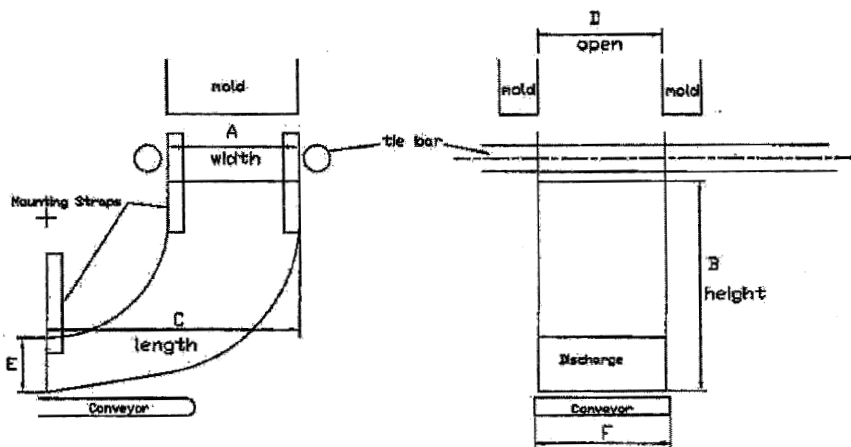

© 2017 MOLDERS CHOICE, Inc.



24 Hour Service - 7 Days a week
1-800-809-4623
 WebSite: www.molderschoice.com • Email: modlers@molderschoice.com

STRAIGHT & TAPERED MOLD SKIRT

STOPS Part Loss.
Drops Parts Directly to Conveyor or Box.

- Mounts to Mold Halves
- Opens and Closes with the Mold for Extra Protection Against Contamination
- Easily Cleaned



No accordion- type pleats

Straight Mold Skirts

Straight PART#	Open Length A	Clearance Height B	Max Mold Open C	PRICE
SMS-20	8"	16"	8"	\$144.00
SMS-25	10"	17"	10"	\$144.00
SMS-30	12"	18"	12"	\$148.00
SMS-35	14"	19"	14"	\$152.00
SMS-40	16"	20"	16"	\$156.00
SMS-45	18"	21"	18"	\$170.00
SMS-50	20"	22"	20"	\$175.00
SMS-55	22"	23"	23"	\$180.00
SMS-60	24"	24"	24"	\$185.00
SMS-65	25"	25"	25"	\$195.00
SMS-70	26"	26"	26"	\$215.00
SMS-75	27"	27"	27"	\$222.00
SMS-80	28"	28"	28"	\$235.00

Tapered Mold Skirts

Tapered PART#	A Standard	B Max Length	C Standard	PRICE
TMS-20	8"	16"	8"	\$158.00
TMS-25	10"	17"	10"	\$155.00
TMS-30	12"	18"	12"	\$162.00
TMS-35	14"	19"	14"	\$167.00
TMS-40	16"	20"	16"	\$177.00
TMS-45	18"	21"	18"	\$186.00
TMS-50	20"	22"	20"	\$192.00
TMS-55	22"	23"	23"	\$197.00
TMS-60	24"	24"	24"	\$210.00
TMS-65	25"	25"	25"	\$220.00
TMS-70	26"	26"	26"	\$235.00
TMS-75	27"	27"	27"	\$236.00
TMS-80	28"	28"	28"	\$247.00

SMS Model

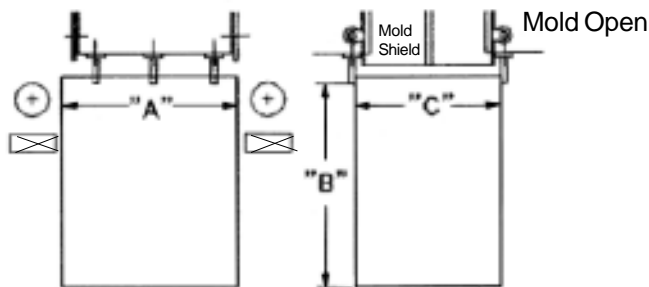

TMS Model

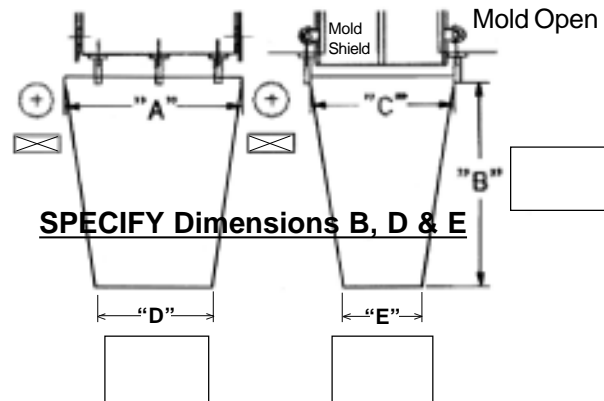

Low-Durometer PVC

- Does not absorb oil or grease
- Resists abrasion, punctures and tears.



© 2014 MOLDERS CHOICE, Inc.

24 Hour Service - 7 Days a week
1-800-809-4623
 WebSite: www.molderschoice.com • Email: molders@molderschoice.com