

3/4" INLINE MANIFOLDS

Part Number	Port Size	Price
IM3-2-AB-4	1/8" OR 1/4"	\$43.00
IM3-2-BD-4	1/8" OR 1/4"	\$43.00
IM3-2-BCD-6	1/8" OR 1/4"	\$48.00
IM3-2-ABC-6	1/8" OR 1/4"	\$49.00
IM3-2-BD-2-2	1/8" OR 1/4"	\$59.00
IM3-2-ABCDE-5-5	1/8"	\$77.00
IM3-4-B-4	1/8" OR 1/4"	\$53.00
IM3-4-BC-8	1/8" OR 1/4"	\$65.00
IM3-4-BD-8	1/8" OR 1/4"	\$65.00
IM3-4-ABC-12	1/8" OR 1/4"	\$77.00
IM3-4-BD-4-4	1/8" OR 1/4"	\$81.00
IM3-4-ABC-6-6	1/8" OR 1/4"	\$93.00
IM3-6-B-6	1/8" OR 1/4"	\$69.00
IM3-6-BC-12	1/8" OR 1/4"	\$87.00
IM3-6-BD-12	1/8" OR 1/4"	\$87.00
IM3-6-ABC-18	1/8" OR 1/4"	\$105.00
IM3-6-BD-6-6	1/8" OR 1/4"	\$103.00
IM3-6-ABC-9-9	1/8" OR 1/4"	\$121.00
IM3-8-B-8	1/8" OR 1/4"	\$85.00
IM3-8-C-8	1/8" OR 1/4"	\$85.00
IM3-8-BD-16	1/8" OR 1/4"	\$109.00
IM3-8-BD-8-8	1/8" OR 1/4"	\$125.00

Price includes end cap and stainless steel 10-32 x 1-1/2" mounting screws.

CUSTOM MANIFOLDS QUOTED UPON REQUEST

© 2009 MOLDERS CHOICE, Inc.



24 Hour Service - 7 Days a week

1-800-809-4623

WebSite: www.molderschoice.com • Email: molders@molderschoice.com

1" INLINE MANIFOLDS

IM4-4-AB-4 1/4" OR 3/8" \$56.00	IM4-4-BD-4 1/4" OR 3/8" \$56.00	IM4-4-BCD-6 1/4" OR 3/8" \$62.00	IM4-4-ABC-6 1/4" OR 3/8" \$62.00	IM4-4-BD-2-2 1/4" OR 3/8" \$73.00	IM4-4-ABCDE-5-5 1/4" \$91.00
IM4-6-B-4 1/4" OR 3/8" \$74.00	IM4-6-BC-8 1/4" OR 3/8" \$96.00	IM4-6-BD-8 1/4" OR 3/8" \$86.00	IM4-6-ABC-12 1/4" OR 3/8" \$98.00	IM4-6-BD-4-4 1/4" OR 3/8" \$103.00	IM4-6-ABC-6-6 1/4" OR 3/8" \$115.00
IM4-9-B-6 1/4" OR 3/8" \$92.00	IM4-9-BC-12 1/4" OR 3/8" \$110.00	IM4-9-BD-12 1/4" OR 3/8" \$110.00	IM4-9-ABC-18 1/4" OR 3/8" \$128.00	IM4-9-BD-6-6 1/4" OR 3/8" \$127.00	IM4-9-ABC-9-9 1/4" OR 3/8" \$145.00
IM4-11-B-8 1/4" OR 3/8" \$116.00	IM4-11-C-8 1/4" OR 3/8" \$116.00	IM4-11-BD-16 1/4" OR 3/8" \$140.00	IM4-11-BD-8-8 1/4" OR 3/8" \$157.00	LENGTH 3.75" 6.25" 8.75" 11.25" OR SPECIAL	

Price includes end cap and stainless steel 1/4"-20 x 2" mounting screws

CUSTOM MANIFOLDS QUOTED UPON REQUEST

© 2009 MOLDERS CHOICE, Inc.



24 Hour Service - 7 Days a week
1-800-809-4623
 WebSite: www.molderschoice.com • Email: molders@molderschoice.com

1-1/2" INLINE MANIFOLDS

Part Number	Port Configuration	Price
IM6-6-AB-4	3/8" OR 1/2"	\$83.00
IM6-6-BD-4	3/8" OR 1/2"	\$83.00
IM6-6-BCD-6	3/8" OR 1/2"	\$91.00
IM6-6-ABC-6	3/8" OR 1/2"	\$91.00
IM6-6-BD-2-2	3/8" OR 1/2"	\$103.00
IM6-6-ABCDE-5-5	3/8" OR 1/2"	\$127.00
IM6-10-B-4	3/8" OR 1/2"	\$111.00
IM6-10-BC-8	3/8" OR 1/2"	\$127.00
IM6-10-BD-8	3/8" OR 1/2"	\$127.00
IM6-10-ABC-12	3/8" OR 1/2"	\$143.00
IM6-10-BD-4-4	3/8" OR 1/2"	\$147.00
IM6-10-ABC-6-6	3/8" OR 1/2"	\$163.00
IM6-14-B-8	3/8" OR 1/2"	\$147.00
IM6-14-BC-12	3/8" OR 1/2"	\$171.00
IM6-14-BD-12	3/8" OR 1/2"	\$171.00
IM6-14-ABC-18	3/8" OR 1/2"	\$195.00
IM6-14-BD-6-6	3/8" OR 1/2"	\$191.00
IM6-14-ABC-9-9	3/8" OR 1/2"	\$215.00
IM6-18-B-8	3/8" OR 1/2"	\$183.00
IM6-18-C-8	3/8" OR 1/2"	\$183.00
IM6-18-BD-16	3/8" OR 1/2"	\$215.00
IM6-18-ABC-12-12	3/8" OR 1/2"	\$267.00

Price includes end cap and stainless steel 1/4"-20 x 2-1/2" mounting screws
CUSTOM MANIFOLDS QUOTED UPON REQUEST



© 2009 MOLDERS CHOICE, Inc.

24 Hour Service - 7 Days a week
1-800-809-4623
 WebSite: www.molderschoice.com • Email: molders@molderschoice.com

2" INLINE MANIFOLDS

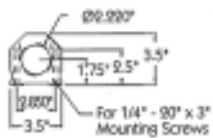
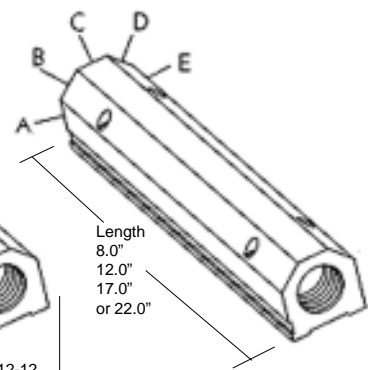
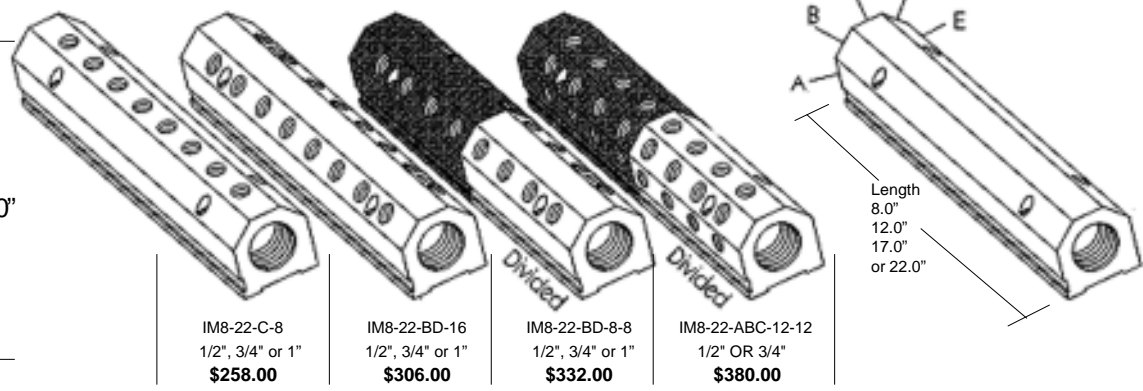
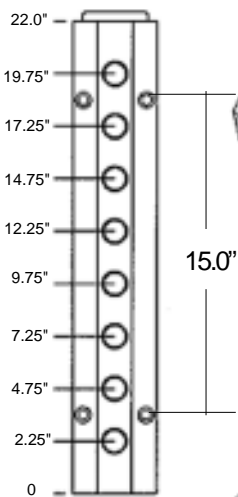
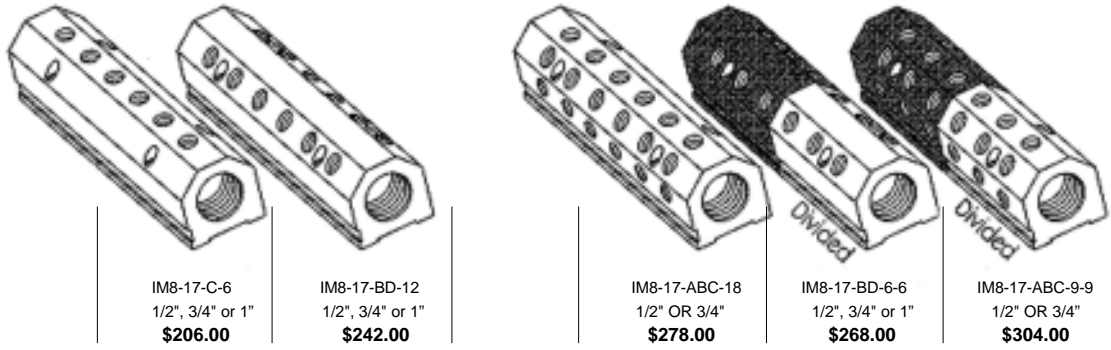
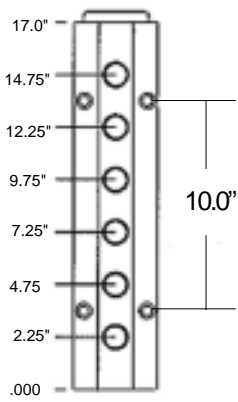
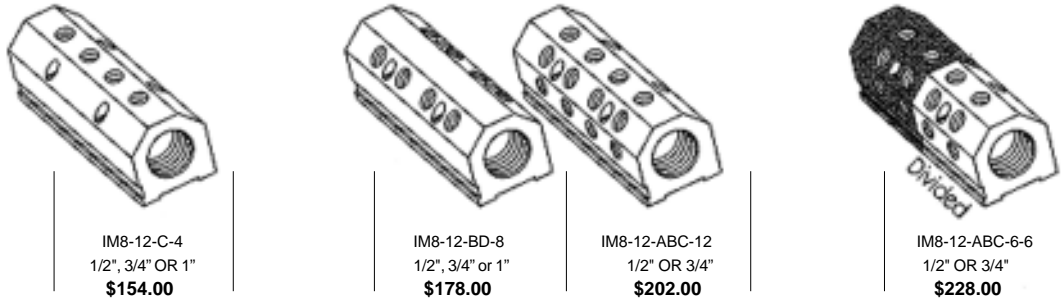
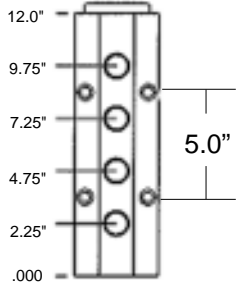
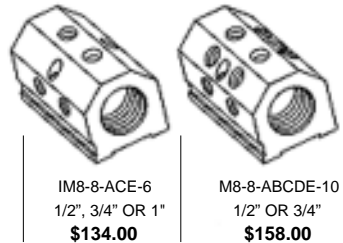
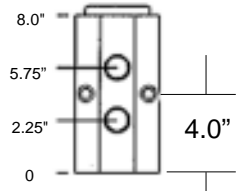

Price includes end cap and stainless steel 1/4" x 20 x 3" mounting screws.
CUSTOM MANIFOLDS QUOTED UPON REQUEST



© 2009 MOLDERS CHOICE, Inc.

24 Hour Service - 7 Days a week
1-800-809-4623
 WebSite: www.molderschoice.com • Email: modlers@molderschoice.com

STEEL WATER MANIFOLDS

The only steel manifolds color coded for hot and cold plumbing

LOW COST - ECONOMY MODELS

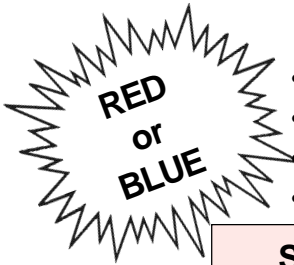

- High quality, robotically welded steel
- Pressure tested by Air @100 psi
- High visibility Red or Blue
- Compact mounting

- 2 Styles available: Straight or Split
- 2" x 2" Steel tubing
- 3/4" NPT Inlet/Outlet main supply
- 1/2" NPT Inlet/Outlet mold supply ports (2-1/2" between centers)

Straight Through

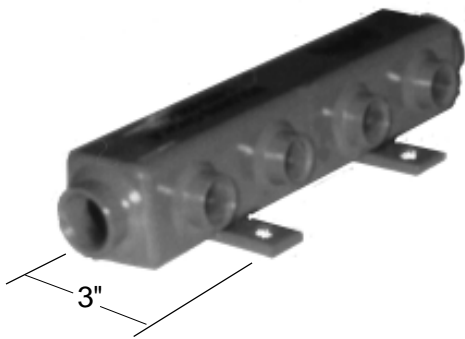

4 Port
Part # ST4
\$40.00
 OAL: 14"
 Add "B" (Blue) or "R" (Red) after part number

Split In/Out

RED and BLUE



4 Port
 (2 in - 2 out)
Part # SP422
\$47.00
 OAL: 14"

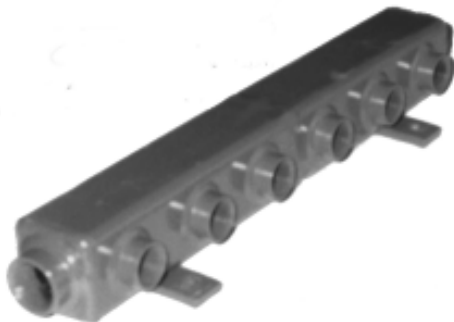

6 Port
Part # ST6
\$47.00
 OAL: 20"
 Add "B" (Blue) or "R" (Red) after part number



6 Port
 (3 in - 3 out)
Part # SP633
\$55.00
 OAL: 20"



8 Port
Part # ST8
\$59.00
 OAL: 26"
 Add "B" (Blue) or "R" (Red) after part number



8 Port
 (4 in - 4 out)
Part # SPL844
\$63.00
 OAL: 26"

© 2009 MOLDERS CHOICE, Inc.



24 Hour Service - 7 Days a week
1-800-809-4623
 WebSite: www.molderschoice.com • Email: molders@molderschoice.com